

SHENZHEN BOND OPTOELECTRONICS CO., LTD.

BDD-18101XXX

PACKAGE DIMENSIONS

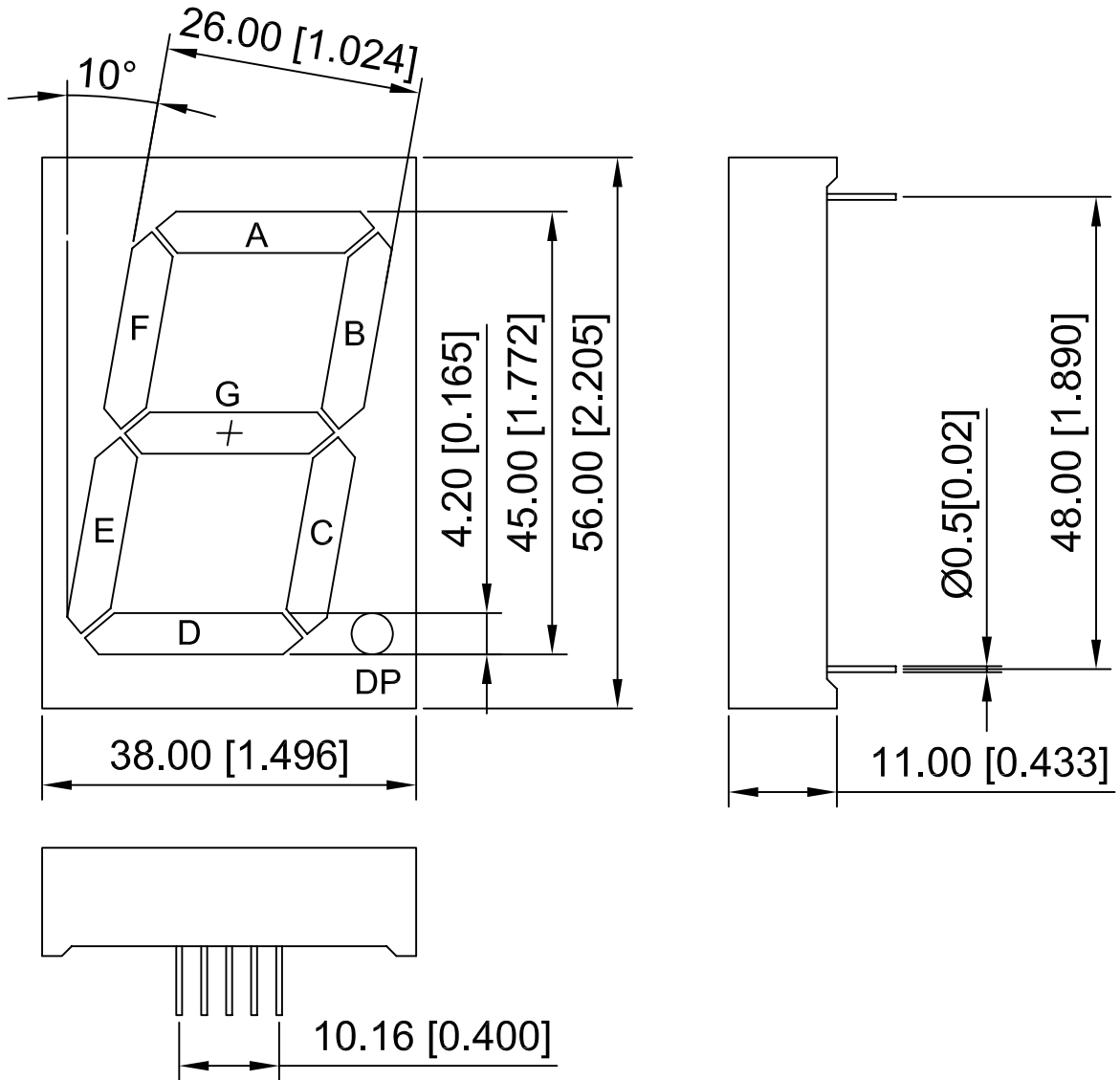

INTERNAL CIRCUIT DIAGRAM

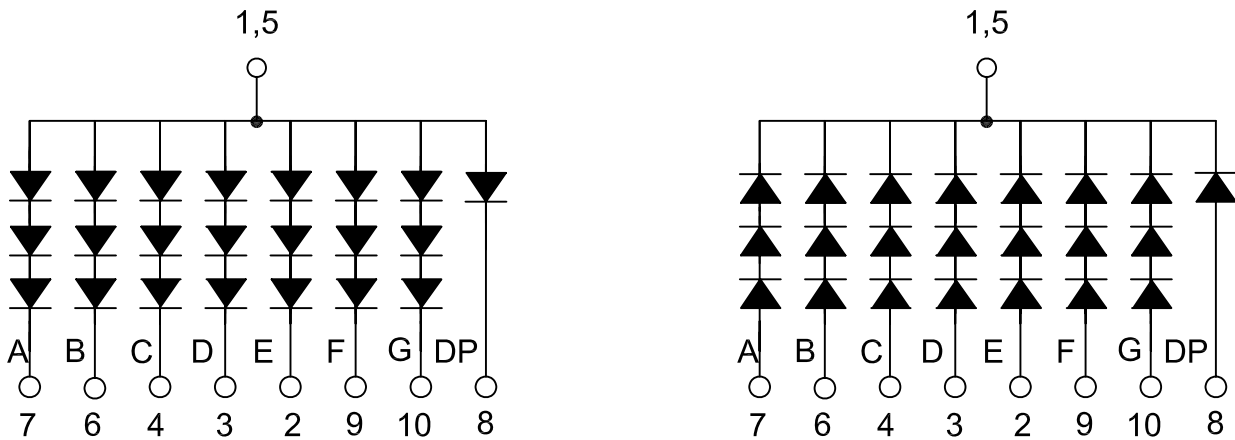

Tel: 0086-755-26685446

Fax: 0086-755-26822679

E-mail: kevin@bond-led.com

Website: <http://www.bond-led.com>

Address: B501, Seat 5, YongLeXinCun, Nanshan District, Shenzhen, China